

EN

## INSTRUCTION FOR USE

CE

MD

**Shower Trolley L1-T1-HYD-ABS**  
**Code: 10068911**

**Shower Trolley L1-T1-EL-ABS**  
**Code: 10068913**

The Koval shower trolley is a height adjustable shower trolley with adjustable tilt function, which is specifically designed for showering and transporting recumbent patients to the showering area.



**WARNING** 

**To avoid injury, always read this Instruction for Use and accompanied documents before using the product.**



**Read Instruction for Use.**

## Contents

Foreword .....	1
Intended Use .....	3
Safety Instructions .....	4
Assembly of Koval Shower Trolley .....	5
Assembly of drain outlet / drain hose .....	5
Preparation .....	6
Koval Shower Trolley driving directions .....	7
Parts designation .....	8
Product Description / Functions .....	9
Adjusting the Height of Shower Trolley Top .....	10
Electric raising and lowering .....	10
Hydraulic raising and lowering .....	10
Shower trolley top inclination .....	10
Raising and lowering the side rails .....	11
Brakes and Steering in the straight direction .....	12
Mattress .....	13
Battery Use .....	14
Transferring the patients with Koval Shower Trolley .....	17
From the Bed .....	17
To the Bed .....	19
From the Sling Lift .....	20
To the Sling Lift .....	21
Using the Koval shower trolley for showering the patient .....	22
Cleaning and Disinfection Instructions .....	23
Care and Regular Yearly Checkups .....	27
Shower Trolley Storage and Transport .....	29
Shower Trolley Operating Conditions .....	30
Technical Specifications .....	31
Technical Specification – Hydraulic Shower Trolley .....	32
Technical Specification – Electric Shower Trolley .....	32
Control box .....	32
Mains cable .....	32
Battery .....	33
Charging accessory .....	33
Handset .....	34
Actuator .....	34
Wiring diagram .....	37
End of Life Disposal .....	38
Dimensions .....	39
Troubleshooting .....	40
Labels .....	42
Label placement .....	43
Approvals and List of Standards .....	44
Maintenance Record sheet .....	45

## Foreword

---

### **Thank you for choosing Koval equipment.**

Your Shower Trolley belongs to a family of high-quality products intended to be used in a variety of care environments, such as senior/assisted living, special care facilities, medical facilities, hospitals, nursing homes, rehabilitation units and other types of healthcare settings. Do not hesitate to contact us in case of queries about the operation or maintenance of your Koval equipment.

### **Please read this Instruction for Use thoroughly.**

Thoroughly read and understand this Instruction for Use (IFU) before using your Shower Trolley. Information from this IFU is essential for proper operation and maintenance of the equipment. Follow these to keep your product safe and to ensure the functioning of your equipment to your satisfaction. Some of the information from this IFU is important for your safety; therefore, please read and understand to prevent any injuries. The product may only be used for its intended purpose.

#### **WARNING**

**Unauthorized modifications of the Koval equipment may affect its safety. Koval will not be held responsible for any accidents, incidents or lack of performance as a result of any such unauthorized modifications.**

### **Report Unexpected Operations or Events.**

In case of unexpected operations or events contact Koval or your local Koval representative. The Koval contact information is printed on the last page of this IFU.

### **Serious Incident**

In case of a serious incident in relation to this medical device involving the user or the patient; the user or the patient must report this serious incident to the medical device manufacturer or the distributor. The user must always report such serious incident to the local competent authority.

In the European Union, the user should also report the serious incident to the local competent authority in the member state where they are located.

### **Servicing and Support**

Your Shower Trolley should be checked once a year by qualified personnel to ensure the operating safety of your product. See Care and Preventive Checkups section. For further

information please do not hesitate to contact Koval or your local Koval representative to receive comprehensive support and servicing to maximize long-term safety, reliability and value of the product. For replacement parts contact Koval or your local Koval representative. The Koval contact information is included on the last page of this IFU.

**Definitions in this IFU:**

**WARNING** 

Safety warning. Failure to understand and follow this warning may result to personal injuries.

**CAUTION**

Failure to follow these instructions may cause damage to all or parts of the system.

**NOTE**

Describes important information about the correct use of this system or product.

**When using this product always follow the appropriate WARNINGS.**

## **Intended Use**

---

This equipment is intended for assisted hygiene care, especially for showering and transporting residents in a variety of care environments, such as senior/assisted living, special care facilities, medical facilities, hospitals, nursing homes, rehabilitation units and other healthcare settings. The equipment is intended specifically for indoor use.

This product should be used according to the intended purpose and these safety instructions. Everyone using this equipment should read and understand these instructions, which are included in this Instruction for Use (IFU). In case of doubts feel free to contact Koval or your local Koval representative at any time.

The Koval Shower Trolley is intended to be used by appropriately trained caregivers familiar with the environment of care, as well as its common practices and procedures, and must follow the guidelines in the Instruction for Use (IFU). The transfer of residents to and from the Koval Shower trolley can be performed by using a ceiling lift, the mobile passive lift or by means of a manual transfer. The Koval Shower Trolley should only be used for intended purpose specified in these Instruction for Use. Use for any other purpose is prohibited.

### **Product lifetime**

The expected product lifetime is ten (10) years depending on the storage conditions and the frequency of use.

The warranty period of the product is three (3) years.

Some product parts, such as casters, handset and the mattress, which are subjected to wear, may need to be replaced during the equipment lifetime according to information in the Instruction for Use (IFU).

Parts must be assembled according to the guidelines in the Instruction for Use (IFU).

### **Transport damage**

Upon delivery check the product and the packaging for damages. Observe the delivery date: visible damages should be reported within 2 days after delivery and hidden damages within 7 days after delivery.

## Safety Instructions

---

**WARNING** ⚠

To prevent explosion or fire never use this product in an oxygen rich environment, near heat sources or flammable anesthetic gases.

**WARNING** ⚠

To prevent the device from tipping do not raise or lower other equipment, such as a bed, shower trolley, lift, or a bedside table, close to it and pay attention to the stationary object when lowering or lifting.

**WARNING** ⚠

To avoid tipping and falling do not use the equipment on floor with recessed drains, holes or slopes exceeding a ratio of 1:50 (1.15°).

**WARNING** ⚠

To prevent entrapment, make sure to keep the patient's hair, arms and feet close to the body during any movement.

**WARNING** ⚠

To prevent electric shock never use this device in close proximity to other electrical equipment.

**WARNING** ⚠

To prevent injuries the patient must never be left unattended.

**WARNING** ⚠

To prevent patient falls during transfer always pull the side rail up and lock it in the vertical position.

**WARNING** ⚠

To prevent patient falls or caregiver injuries make sure that there are two caregivers present during the transfer and showering of a patient if this is necessary according to the patient state.

**WARNING** ⚠

Use of this equipment adjacent to or stacked with other equipment should be avoided because it could result in improper operation. If such use is necessary, this equipment and the other equipment should be observed to verify that they are operating normally.

## **WARNING** ⚠

Portable RF communications equipment (including peripherals such as antenna cables and external antennas) should be used no closer than 30 cm to any part of the Shower trolley, including cables specified by the manufacturer. Otherwise, degradation of the performance of this equipment could result.

## **Assembly of Koval Shower Trolley**

---

**Follow these steps:**

- 1 Unpack the Koval Shower Trolley.
- 2 Cut the straps securing the shower trolley to the pallet.
- 3 Push the shower trolley off the pallet.
- 4 Remove all protective foil.
- 5 The shower mattress is transported upside down; therefore, remove the foil holding the mattress and turn it around.
- 6 Take the drain hose and lead it through drain hole on shower trolley top.
- 7 Raise the side rails.

## **Assembly of drain outlet / drain hose**

---



1 Insert the drain outlet into the drain hole on the mattress and the trolley top.



2 Tighten the drain outlet from the bottom.



3 Attach the drain hose.

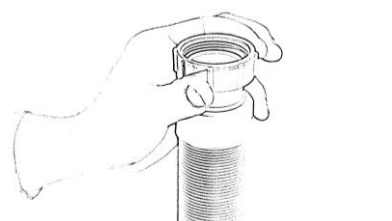



## Preparation

---

### Before First Use (10 Steps)

- 1 Visually inspect the Koval Shower Trolley for transport damages.

**WARNING** ⚠

**There is a 2-day deadline for reporting visible damages and a 7-day deadline for reporting hidden damages.**

- 2 The packaging should be recycled according to local regulations.
- 3 Confirm that all parts of the product have been included in the package. Refer to Parts Designation section. In case of missing or damaged parts do NOT use the product!
- 4 Read the IFU.
- 5 Disinfection of the product should be carried out according to Cleaning and Disinfection Instructions.
- 6 Perform functionality testing of the Koval Shower Trolley. Refer to Regular Yearly Checkups section.
- 7 Charge the battery for 24 hours.
- 8 Store the Koval Shower Trolley in a dry, well-ventilated place out of direct sunlight.
- 9 IFU should be kept in a designated area and should be easily accessible at all times.
- 10 Have an emergency response plan readily available in case of a patient emergency.

### Before Every Use (5 Steps)

1

**WARNING** ⚠

**To avoid injury, check for proper operation of basic functions before use.**

- 2 Check that all parts are in place.  
Refer to the Parts Designation section.
- 3 Carefully inspect the product for damages.
- 4 In case of missing or damaged parts do NOT use the product!

5

**WARNING** ⚠

**To prevent cross-contamination, always follow the disinfection instructions from this IFU.**

- 6 Make sure that the battery is charged.

## Koval Shower Trolley driving directions

---

The driving direction from the patient's perspective during transport is illustrated below.

**Head end**

**Left side**

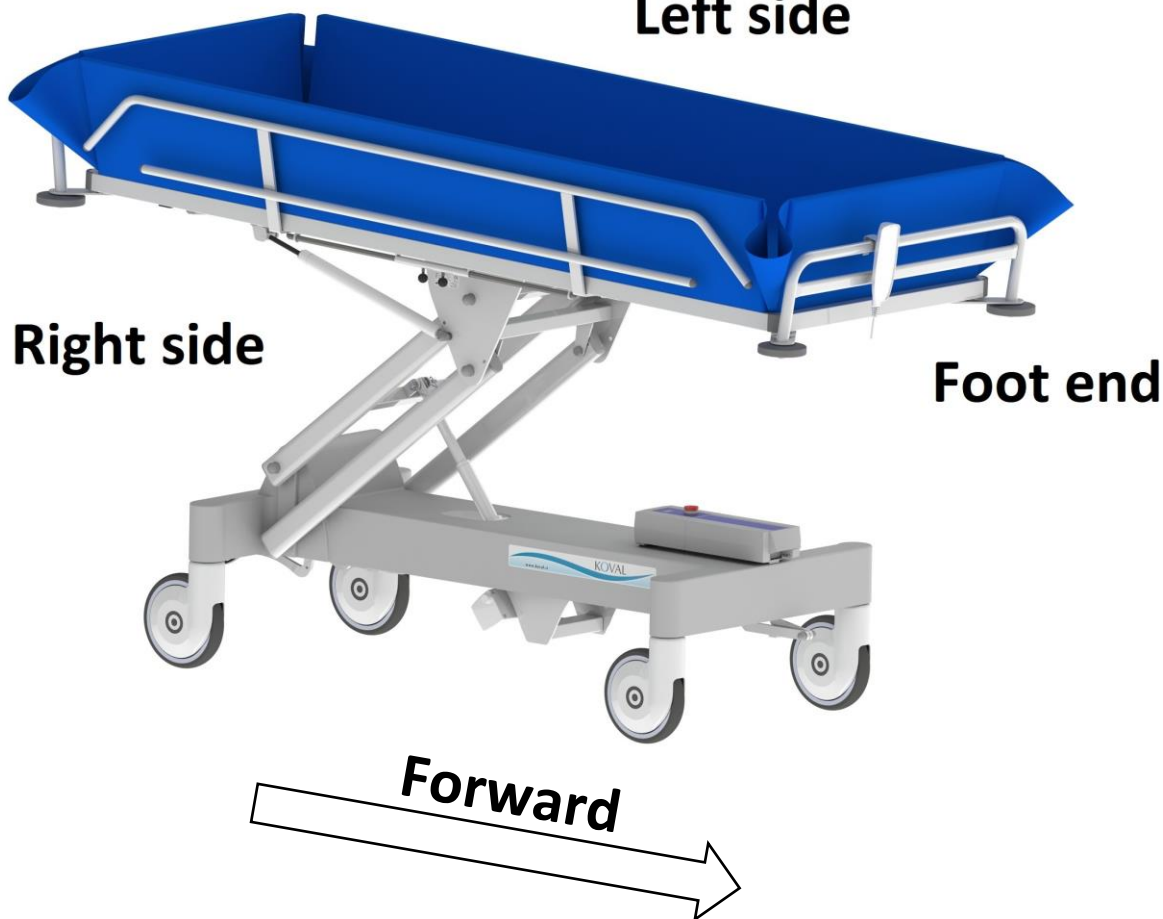

## Parts designation

---



1 Shower mattress

2 Head cushion

3 Drain outlet

4 Drain hose

5 Side rails

6 Foot end rail

7 Head end rail

8 Bumper wheel

9 Tilt control lever

10 Shower trolley top

11 Safety mechanism

12 Caster

13 Front left directional caster

14 Gas spring

15 Central brake / straight steering

16 Electric actuator

17 Control box

18 Handset

19 Battery

20 Emergency stop button

21 Charger

22 Hydraulic (non electrical shower trolley only)

23 Pedal for raising/lowering (non electrical shower trolley only)

24 Plastic base cover

## Product Description / Functions

---

The Koval Shower Trolley is designed for assisted hygiene care, especially for showering and transporting residents in a variety of care environments.

The shower trolley height can be adjusted with a hydraulic or electric actuator for raising/lowering the trolley top. The height of the trolley top can be adjusted in the range between 54cm and 97cm (casters Ø150mm) or 60cm and 103cm (casters Ø200mm). The trolley top has adjustable tilt position (0°–5°), which allows the water from inside the mattress to flow outside through a flexible drain hose. The flexible drain hose must be routed to the floor drain or toilet.

The metal frame is electrostatically powder coated and features a special anti-corrosion protection. Four locking casters with a 150 or 200mm diameter for improved manoeuvrability. The left front caster is directional and can be locked in position for steering in a straight direction and easy manoeuvring.

The shower trolley features two end rails, which can be used as push handles, each equipped with a corner bumper wheels Ø100mm. Their function is to prevent damage to the shower trolley and walls during the transport.

**WARNING** 

**To avoid damage to the product, use the products exclusively to transfer patients. Transferring other objects is strictly prohibited.**

**WARNING** 

**To avoid damage to the equipment, the Koval Shower Trolley should exclusively be used indoors.**

**WARNING** 

**To avoid injury, ensure weekly monitoring of all functions of the shower trolley.**

## Adjusting the Height of Shower Trolley Top

### Electric raising and lowering



HB81

The raising and lowering of the electric shower trolley top can be controlled via a handset.

Unhook the handset from its holder.

To raise electric shower trolley top press the UP arrow button on the handset.

To lower the electric shower trolley top press the DOWN arrow button on the handset.

### Hydraulic raising and lowering



To raise the hydraulic shower trolley top pump the foot pedal using a full range of motion.

To lower the hydraulic shower trolley top lift up the pedal using your foot.

The pedal can be operated from both sides of the shower trolley.

### Shower trolley top inclination

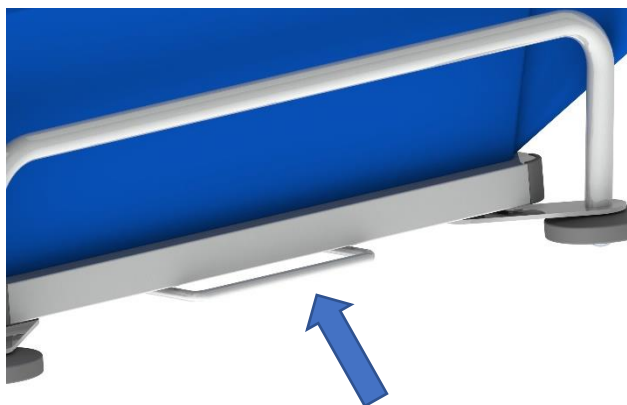

**The reverse Trendelenburg position:** lift the lever with one hand and then use the other hand to adjust shower trolley top inclination.

**Horizontal position:** lift the lever with one hand and then use the other hand to push the shower trolley top into horizontal position.

## Raising and lowering the side rails

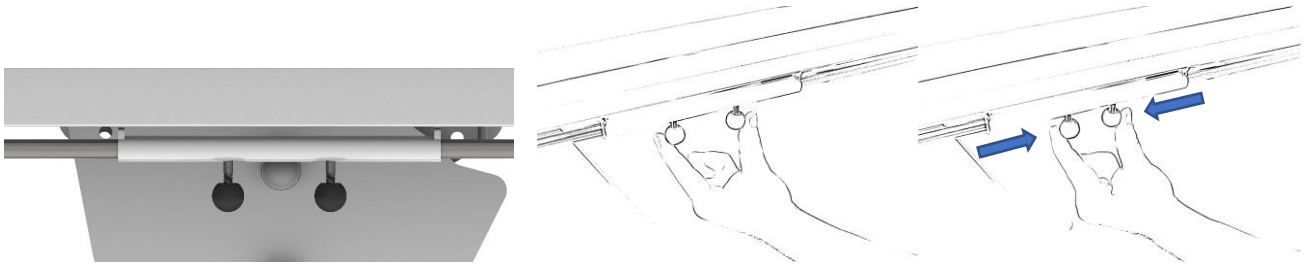

### Lowering the side rails:

Using one hand push the pins together to the middle of the shower trolley top to release the side rail.

### Raising the side rails:

Pull the side rail up until it locks in the vertical position.

#### **WARNING** ⚠

The shower trolley top can be lowered or raised only when foldable side rails are in the uppermost position. If the side rails are folded all the way down, lowering or raising could lead to injuries to the operator or the patient, or damage to the rails.

#### **WARNING** ⚠

To avoid injuries lower one of the side rails before transferring the patient from the bed to the Koval Shower Trolley.

#### **WARNING** ⚠

To avoid injuries during patient transport, pull the side rails up and lock them in the vertical position before transporting the patient.

## Brakes and Steering in the straight direction

### Central braking system with one directional caster:

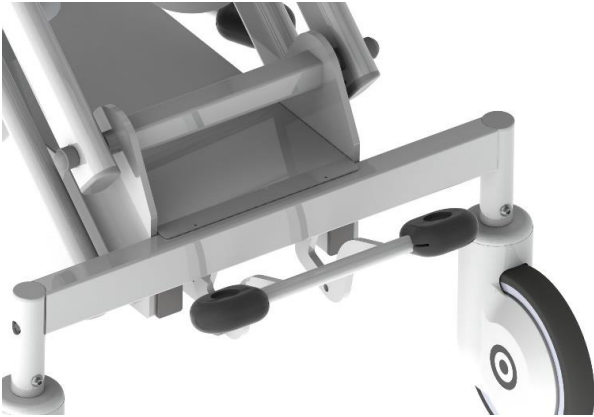

**The lever is in the uppermost position** (the front left caster is locked in the direction of the transport for steering in the straight direction and easy manoeuvring).



**The lever is in the middle position** (the casters are unlocked).



**The lever is in the lower position** (the casters are in locked braking position).

#### **WARNING** ⚠

**To avoid injuries, ensure that the central brake is locked during showering and when transferring the patient from bed to the shower trolley.**

#### **WARNING** ⚠

**To avoid injuries, always lock the central brake when trolley is stationary.**

## Mattress

The shower trolley features a removable mattress and head cushion/wedge pillow, which must be washed and cleaned after each use. The head cushion/wedge pillow provides extra comfort for the patient.

The drain is positioned in the middle of the mattress's foot end.

## Drain outlet



Plastic and metal option.

## Drain plug



The drain plug is fastened with a nylon string to the foot end rail.

## Drain hose



The flexible drain hose is 700mm long and can be extended up to 2000mm. The flexible drain hose is supplied together with the Koval shower trolley. The hose is connected to the drain outlet on the mattress. The mattress's design together with the inclination of the shower trolley top allows for proper drainage. Before showering make sure that the drain hose end has been routed in the floor drain, toilet or sink.

To reduce water dripping on floor after use bend the drain hose end upwards and place it into the drain outlet on the mattress.

### **WARNING** ⚠

**To prevent the patient from drowning always keep patient head raised above the water surface and make sure that there are two or more caregivers present during the bathing process.**



## Battery Use

The Koval shower trolley batteries must be charged at least 24 hours before first use or, if possible, longer to ensure proper functioning and prolong the lifetime of a battery.

Batteries do not require any type of maintenance, only recharging.



### Low Battery Charge Warning

When the battery reaches about 25% of capacity, an audible alarm will sound.

### How to Change the Battery

Remove the battery by using both hands. Press on the snap system under the battery and lift the battery up. The unhooked battery can easily be removed.

Take the fully charged battery and insert the battery by sliding it onto the steel guide towards the CHJ2 control box. Make sure the tab clicks when snapping into fixed position.

#### **WARNING** ⚠

**Always use the replacement battery of the same type as the original factory-installed battery.**

#### **WARNING** ⚠

**Replace the battery only if the shower trolley is empty.**

#### **WARNING** ⚠

**If contents of the battery come in contact with your eyes, immediately rinse with plenty of water and seek medical attention.**

#### **WARNING** ⚠

**To avoid injuries do NOT crush, puncture, open, dismantle or otherwise mechanically interfere with the battery.**

#### **WARNING** ⚠

**Inhalation of the battery contents can cause respiratory irritation. Provide for fresh air and seek medical attention.**

### **CAUTION**

**Be careful not to drop the battery.**

## Charging

The **green LED** on the wall charger indicates that the power supply is on, whereas a **yellow LED** indicates that batteries are charging. After the battery is recharged (about 5 hours), the **yellow LED** switches off. To ensure that the Koval shower trolley remains fully operational at all times, we recommend purchasing a replacement battery. The battery charger is designed to automatically adapt to the voltage and frequencies of 100–240V~ / 50–60Hz and is provided with an automatic battery charge limiter.

### **WARNING** ⚠

**To prevent damages to the battery, the battery must never be completely drained. After an audible alarm is triggered the battery must not be used and must immediately be charged.**

### **WARNING** ⚠

**Make sure that the mains voltage corresponds to the voltage on the rating plate of the battery charger.**

### **WARNING** ⚠

**Use only original charger and charging cable supplied by the manufacturer.**

## Charging Intervals

- Charging the battery on a daily basis improves the charging capacity and extends its service life.
- To prolong the life of the battery charge the battery at regular intervals, i.e. every night.
- If the Koval shower trolley is frequently used, we recommend to use two batteries, one to operate the product and one as a stand-by battery in the charger.
- To prolong the life of the battery life disconnect the battery during prolonged storage.

## Storage of Batteries

- The battery is charged upon delivery, but we recommend you to recharge the battery upon receipt to slow down self-discharge.
- The battery will slowly self-discharge when not used.
- A battery, which is not used, must be stored at a temperature between -15°C and +40°C and relative humidity from 20% to 80% – non-condensing.
- For maximum battery performance, store the battery at a temperature bellow 40°C.
- Batteries must be recharged at least every six months.

## Battery Service Life

Make sure to always have two functional batteries on hand, one for operation of the product and other as a stand-by battery. If you use a freshly charged battery and the battery LED indicator starts to flash and beep after a few operations are carried out, it is time to order a new battery.

**NOTE:** Duty cycle: 10% or 2 min of continuous use followed by 18 min of non-use.

**NOTE:** To avoid loss of operation, charge the battery when the warning audible alarm sounds.

**NOTE:** To discard the batteries turn to the local authorities for advice.

## Installing the Charger

Choose a well-ventilated area away from the main access and patient environment, bathrooms or any other wet areas.

The battery charger is designed for use in dry surroundings.

Use two screws to mount the charger on the wall.

## Emergency Stop Button

If, for any reason, the Koval electric shower trolley cannot be controlled via the hand control buttons, stop the movement of the shower trolley by pressing the emergency stop button (See Figure 1). In this case, contact qualified personnel for help. If you press the red emergency stop button on the control box, all the battery powered functions will be switched off.

If the emergency stop button is pressed unintentionally, it can be reset by turning the button clockwise until it springs out.



Figure 1

## Transferring the patients with Koval Shower Trolley

---

### From the Bed

(19 steps)

- 1 Apply the bed's casters brakes.
- 2 If possible, raise the bed to an ergonomic height.
- 3 Fold down the Koval shower trolley's side rail on the side of the transfer.
- 4 Lower the bed's side rail on the side of the transfer, if there is any.
- 5 Have two caregivers stand on each side of the bed.
- 6 Position the patient closer to the side of the transfer.
- 7 Turn the patient to his/her side, away from the side of the transfer.



Fig. 1

- 8 The caregiver, the patient is facing, shall hold the patient (see Figure 1).

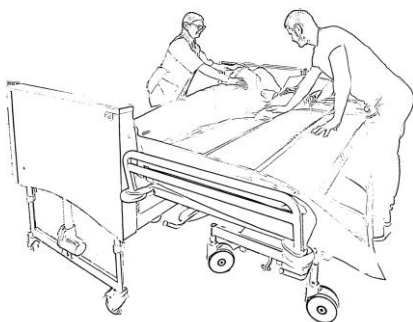

Fig. 2

- 9 Fold down the remaining Koval shower trolley's side rail, opposite the side of the transfer and bed.
- 10 The second caregiver will set the desired height and position the Koval shower trolley along the bed (see Figure 2).

#### **WARNING** ⚠

**To avoid patient falls during the transfer always make sure that the brakes are applied on all equipment being used.**

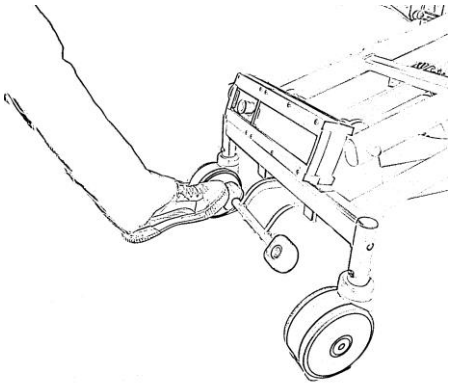

Fig. 3

11 Apply the central brake on the Koval shower trolley (see Figure 3)

12 Turn the patient back to his/her back and on the Koval shower trolley.

**WARNING** ⚠

To avoid patient falls, make sure that the patient is positioned pursuant to this IFU.

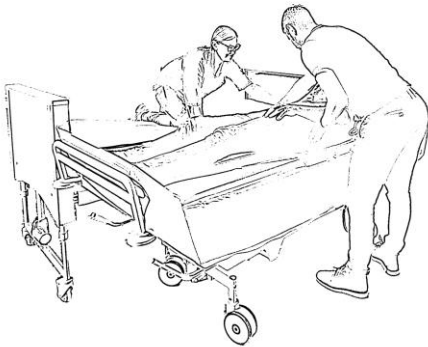

Fig. 4

13 Both caregivers must assist the patient to move towards the middle of the Koval shower trolley (see Figure 4).

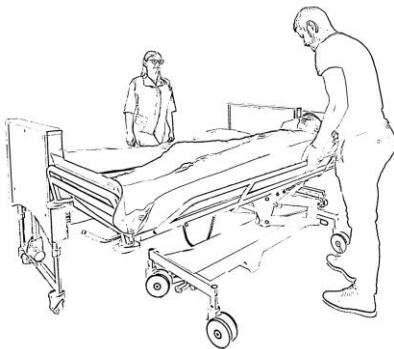

Fig. 5

14 Fold up the Koval shower trolley's side rail, opposite from the side of the transfer and bed (see Figure 5).

15 Place the head cushion under the patient's head for comfort.

16 Release the central brake on Koval shower trolley.

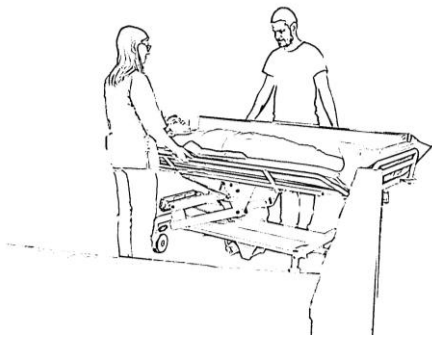

Fig. 6

17 Move the Koval shower trolley away from the bed and fold up the Koval shower trolley's side rail on the side of the transfer (see Figure 6).

18 If the patient is undressed, cover him/her with a blanket.

19 Adjust the Koval shower trolley to an ergonomic height to suit the caregivers.

**WARNING** ⚠

**To avoid patient falling from the trolley make sure that all side rails are folded up and locked.**

**WARNING** ⚠

**To avoid entrapment, make sure to keep the patient's hair, arms and feet close to the body during any movement.**

**WARNING** ⚠

**To avoid the patient falls or caregiver injuries make sure that there are two or more caregivers present during the transfer of the patient.**

## **To the Bed**

### **(14 steps)**

1 Apply the bed's casters brakes.

2 If possible, raise the bed to an ergonomic height.

3 Lower the bed's side rail on the side of the transfer, if there is any.

4 Fold down the Koval shower trolley's side rail on the side of the transfer, towards the bed.

(See Fig. 6).

5 Position the Koval shower trolley along to the bed (see Figure 5).

**WARNING** ⚠

**To avoid patient falls during the transfer always make sure that the brakes are applied on all equipment being used.**

- 6 Apply the Koval shower trolley's central brake (see Figure 3).
- 7 Fold down the remaining Koval shower trolley's side rail, opposite from the side of the transfer. (See Fig. 5).
- 8 Both caregivers must assist the patient to move towards the bed (see Fig. 4).
- 9 Turn the patient to his/her side, away from the side of the transfer. Make sure the patient is not lying on the Koval shower trolley's mattress (see Figure 2).
- 10 The caregiver, the patient is facing, shall hold the patient (see Figure 1).
- 11 Release the Koval shower trolley's central brake.
- 12 Move the Koval shower trolley away from bed.
- 13 Turn the patient on his/her back.
- 14 Disinfect the Koval shower trolley after each use to prevent cross-contamination according to the "Cleaning and Disinfection Instructions" section.

**WARNING** 

**To avoid patient falling from the trolley make sure that all side rails are in a locked position.**

**WARNING** 

**To avoid patient falls or caregiver injuries make sure that there are two or more caregivers present during the transfer of the patient.**

## **From the Sling Lift**

### **(10 Steps)**

For any questions related to the sling lift, refer to the IFU of the respective sling lift. These steps of transferring the patient apply to both floor and ceiling sling lifts.

- 1 Lower the Koval shower trolley to the lowest height.
- 2 Apply the Koval shower trolley's central brake.
- 3 Make sure both side rails are folded up.

**WARNING** 

**To avoid patient falls make sure that the patient is positioned in accordance with this IFU.**

- 4 Lower the lift with the patient on the Koval shower trolley.
- 5 Detach the sling from the lift.
- 6 Move the lift away from the Koval shower trolley.
- 7 Adjust the Koval shower trolley to an ergonomic height.

- 8 Remove the sling from under the patient.
- 9 Place the head cushion under the patient's head for comfort.
- 10 Release the Koval shower trolley's central brake.

### **To the Sling Lift**

#### **(8 Steps)**

For any questions related to the sling lift, refer to the IFU of the respective sling lift. These steps of transferring the patient apply to both floor and ceiling sling lifts.

- 1 Apply the Koval shower trolley's central brake.
- 2 Raise the Koval shower trolley to an ergonomic height.
- 3 Position the sling under the patient.
- 4 Lower the Koval shower trolley to its lowest height.
- 5 Position the lift over the patient.
- 6 Attach the sling to the lift.
- 7 Lift the patient up from the Koval shower trolley.
- 8 Disinfect Koval shower trolley after each use to prevent cross-contamination according to the "Cleaning and Disinfection Instructions" section.



## Using the Koval shower trolley for showering the patient

---

**WARNING** ⚠

**Always drain the water before transporting the patient.**

- 1 Move the Koval shower trolley to a bathroom with a shower and toilet/sink.
- 2 Make sure that the drain hose end has been placed in the floor drain, toilet or sink.
- 3 Apply the central brake and set up the Koval shower trolley to a comfortable ergonomic working height.
- 4 Grab the shower handle and hold it over the Koval shower trolley.

**WARNING** ⚠

**To prevent scalding always check the temperature of water with your bare hand before using the water to shower the patient. Do not use gloves as it may serve as an insulation and cause incorrect estimation of the water.**

- 5 Turn on the water.
- 6 Adjust the temperature and water flow to suit the patient.
- 7 Shower the patient.
- 8 After the shower, turn off the water and dry the patient.
- 9 Release the central brake.
- 10 Raise the Koval shower trolley to an ergonomic height and transport the patient back to the room.
- 11 Disinfect the Koval shower trolley after each use to prevent cross-contamination according to the “Cleaning and Disinfection Instructions” section.

**WARNING** ⚠

**When showering the patient raise the side rails into the vertical position. Failure to do so can result in the water overflow or patient falling from the shower trolley.**

**WARNING** ⚠

**When showering the patient remove the drain plug when the tap is open to prevent overflow.**

**WARNING** ⚠

**When showering the patient with shampoo the surface of the pillow can become slippery. Be careful to prevent the patient from sliding.**

## Cleaning and Disinfection Instructions

---

The shower trolley has a removable PVC-coated mattress, which must be washed and cleaned after each use.

Make sure to have the Material Safety Data Sheets (MSDS) available for the disinfectant being used.

**NOTE:** Be careful with using alcohol-based detergents with alcohol content higher than 40%, otherwise the upper flat pad may be damaged.

Do not use detergents containing solvents, such as trichlorethylene. This can damage the PVC upper flat pad.

Do not use disinfectants based on iodine, because they can lead to discoloration.

Repeated cleaning / disinfection should have no effect on the equipment during its expected service life of equipment.

**Regular cleaning with mild detergents extends product lifetime.**

**WARNING** 

**To avoid eye or skin irritation never use disinfectants in the presence of a patient.**

**WARNING** 

**To prevent cross-contamination always follow the disinfection instructions in this IFU.**

**WARNING** 

**Chemical cleaning is prohibited.**

**WARNING** 

**Never clean the mattress and head cushion in gas sterilization unit.**

**WARNING** 

**To avoid eye and skin damage always use goggles and gloves. In case of contact rinse with plenty of water. If eyes or skin becomes irritated, immediately contact a physician. Always read the IFU and the Material Safety Data Sheet (MSDS) of the disinfectant label.**

**WARNING** ⚠

**Do not use a steam washer, washing tunnel, or high pressure jet cleaners.**

**WARNING** ⚠

**Do not clean the surface with abrasive sponges and cloths.**

**Accessories for Disinfecting the Koval Shower Trolley**

- Protective gloves
- Protective glasses
- Spray bottle with disinfectant
- Spray bottle with water (or use shower handle)
- Cloths - wet and dry
- Disposable towels
- Soft bristle brush
- Long handle soft bristle brush

**After each use wash the mattress with water and clean it with disinfectant.**

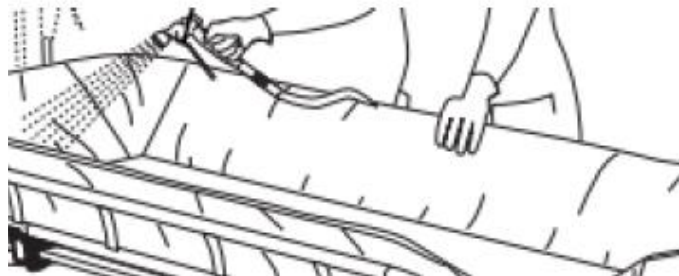

**For thorough cleaning remove the mattress from the shower trolley.**

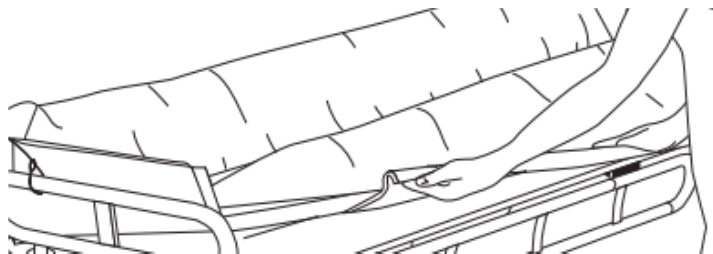

## **Always Follow these 24 Steps for Proper Cleaning and Disinfection**

### **Removing visual residues (Steps 1–4 of 24)**

- 1 Remove the drain hose together with all parts and the cushions.
- 2 Remove visible residue from the Koval shower trolley using a cloth soaked in water or, if suitable, by spraying/showering water and using a brush and/or using a clean cloth. Start from the top and move downwards.
- 3 Remove visible residue from all removed parts with a cloth soaked in water or using the shower water and a brush and/or using a clean cloth.
- 4 Spray water into the drain. Use a long handle brush to scrub the drain hole in the mattress and the drain outlet.

### **Cleaning (Steps 5–13 of 24)**

- 5 Put on protective gloves and glasses.
- 6 Make sure that the disinfectant is mixed according to the instructions on the disinfectant bottle label or according to the mixing ratio stated in the shower panel's IFU.
- 7 Spray disinfectant on the Koval shower trolley. Thoroughly scrub with a brush especially the handles and the handset.
- 8 Thoroughly rinse the Koval shower trolley with water with a temperature of approx. 25 °C. Repeat until all traces of disinfectant are removed.
- 9 Spray disinfectant on the removed parts, the drain hole in the mattress and the drain outlet. Thoroughly scrub with a brush soaked in disinfectant.
- 10 Thoroughly rinse the removed parts, the drain hole in the mattress and the drain outlet with water. Repeat until all traces of disinfectant are removed.
- 11 Soak a cloth in disinfectant and wipe the remaining areas, such as the chassis.
- 12 Use a new wet cloth to remove all traces of disinfectant on other areas. When removing disinfectant periodically rinse the cloth under running water.
- 13 If the disinfectant cannot be removed, spray the water on the affected part and wipe off with disposable towels.  
Repeat until all traces of disinfectant are removed.

### **Disinfection (Steps 14–24 of 24)**

- 14 Spray the disinfectant on the Koval shower trolley.
- 15 Allow for disinfection time according to the instructions on the product label.
- 16 Spray the removed parts, the drain hole in the mattress and the drain outlet with disinfectant.

- 17 Allow for disinfection time according to the instructions on the product label.
- 18 Soak a cloth in disinfectant and wipe all remaining areas, such as the chassis.
- 19 Allow for disinfection time according to the instructions on the product label.
- 20 Spray or shower water with the temperature of approx. 25°C and wipe with a clean cloth to remove all traces of the disinfectant from the Koval shower trolley. When removing disinfectant periodically rinse the cloth under running water.
- 21 Spray or shower water with the temperature of approx. 25°C and wipe with a clean cloth to remove all traces of the disinfectant from the removed parts, the drain hole in the mattress and the drain outlet. When removing disinfectant periodically rinse the cloth under running water.
- 22 Spray or shower water with the temperature of approx. 25°C and wipe with a clean cloth to remove all traces of the disinfectant from the remaining areas, such as a chassis. When removing disinfectant periodically rinse the cloth under running water.
- 23 If the traces of disinfectant cannot be removed, spray water on the affected part and wipe off with disposable towels. Repeat until all the traces of the disinfectant has been removed.
- 24 Let all parts to dry.

**WARNING** 

**The product should always be cleaned between patients.**

## Care and Regular Yearly Checkups

The Koval Shower Trolley is subject to normal wear and tear; therefore, the following actions should be performed as specified to make sure that the product retains its original manufacturing specification.

Manufacturer or Koval's qualified personnel or distributor shall carry out a regular yearly checkup by prior agreement.

**WARNING** 

**To avoid malfunction resulting in injury make sure to carry out regular inspections and follow the recommended maintenance schedule. In some cases, due to heavy use of the product and exposure to aggressive environment, more frequent inspections should be carried out. Local regulations and standards may be more stringent than the recommended maintenance schedule.**

**NOTE:** Do not carry maintenance and servicing while the product is used

Responsibilities of the Caregiver	AFTER EVERY USE	Every WEEK	Every YEAR
Disinfection	X		
Visually check all exposed parts		X	
Visually check mechanical attachments		X	
Perform functionality testing		X	
Check the handset and the cable (electric shower trolley)		X	
Check and clean casters		X	
Visually check the battery and the charger (electric shower trolley)		X	
Check the mattress and the head cushion/wedged pillow		X	
Regular yearly checkups by qualified personnel only			X

**WARNING** 

**To avoid injuries of the patient and caregiver never modify the equipment or use incompatible parts.**

## **Responsibilities of the Caregiver**

Responsibilities of the caregiver shall be carried out by personnel with sufficient Shower Trolley knowledge following the instructions in this IFU.

### **Daily**

#### **Disinfection**

- Disinfect the Koval Shower Trolley immediately after every use. Use recommended concentrations of standard disinfectants and cleaning agents. For additional cleaning/disinfecting instructions see “Cleaning and Disinfection Instructions” section.

### **Weekly**

#### **Visually check all exposed parts**

- Particularly check areas exposed to physical contact with the patient or the caregiver. Check for potential cracks or sharp edges that could lead to injuries by the patient or the caregiver or that could become unhygienic.
- Check the drain hose together with all the parts.
- Tilt the shower trolley top. Visually check the two bolts fixing the shower trolley top to the chassis. No gaps should be present.
- When the trolley is tilted check for cracks in the shower trolley.

#### **Test functionality by:**

- Verifying the safety lock system on the side rails.
- Verifying that the hydraulic system is working smoothly (raising and lowering).
- Verifying that the electric actuator is working smoothly (raising and lowering) – electric model only.
- Testing the central brakes.

#### **Checking the handset and cable (the Koval electric shower trolley)**

- Visually check the condition of the handset and its cable.

## Checking and cleaning casters

- Check that all casters are securely fixed and can rotate and swivel freely. Always clean with water (the functioning can be affected by soap, hair, dust and chemicals from the floor cleaning solutions).
- Check the central brakes and straight steering.

## Visually check the battery and the charger (the Koval electric shower trolley)

- Visually check the condition of the battery charger, its cable and the battery. In case of damages remove and replace immediately.

## Check the mattress and the head cushion/wedge pillow

- Make sure there are no cracks or tears that would allow water to penetrate into the filling. In case of damage replace damaged parts to avoid cross-contamination.

## Yearly Checkups by Qualified Personnel Only

- The Koval shower trolley must be checked once a year in accordance with the Maintenance and Repair Manual.

### **WARNING**

**To avoid injuries and/or diminished safety of the product the maintenance activities must be carried out at set intervals by qualified personnel with appropriate tools and parts, as well as proper knowledge of the procedures. Qualified personnel must be certified for the maintenance of this device.**

**NOTE:** All responsibilities of the caregiver must be checked when performing the services executed by Qualified Personnel.

## Shower Trolley Storage and Transport

Store the Koval Shower Trolley in a dry, well-ventilated area at room temperature and out of direct sunlight (UV-radiation). The storage temperature must range from -10°C to 40°C, storage humidity must range from 20% to 80%. Atmospheric pressure: 500 to 1060hPa. Avoid excessive pressure on the mattress during storage. Follow all the necessary precautions during transport: the shower trolley top must be in the lowest possible position with the side rails fully locked.

### **CAUTION:**

Failure to lock the central brakes can cause the shower trolley move automatically.



## **Shower Trolley Operating Conditions**

The operating temperature must range from +5°C to +40°C. Humidity must range from 20% to 80% and atmospheric pressure must range from 700 to 1060hPa.

## Technical Specifications

### 10068911 - SHOWER TROLLEY L1-T1-HYD-ABS



**L1 - one-piece trolley top**  
**T1 - trolley top inclination via gas springs 0°- 5°**  
**ABS - plastic base cover**  
**HYD - hydraulically raising/lowering**  
**Side rails with safety mechanism**  
**Straight steering**  
**Central brake**  
**Shower trolley top Width: 650 mm**  
**Shower trolley top Length: 1900 mm**  
**Shower trolley top Height: 540- 970 mm (casters Ø150 mm)**  
**600- 1030 mm (casters Ø200 mm)**

### 10068913 - SHOWER TROLLEY L1-T1-EL-ABS



**L1 - one-piece trolley top**  
**T1 - trolley top inclination via gas springs 0°- 5°**  
**ABS - plastic base cover**  
**EL - electrically raising/lowering**  
**Side rails with safety mechanism**  
**Straight steering**  
**Central brake**  
**Shower trolley top Width: 650 mm**  
**Shower trolley top Length: 1900 mm**  
**Shower trolley top Height: 540- 970 mm (casters Ø150 mm)**  
**600- 1030 mm (casters Ø200 mm)**

- Foldable side rails with safety mechanism and height of 205mm.
- Height of the trolley mattress: 270mm.
- Mattress with flexible drain hose

### NOTE

We reserve the right to make technical changes.

Measurements can deviate for +/- 2%.

SWL	Weight	Maximum total weight (model + patient + water)
SWL (Safe Working Load = patient + water)	200kg	
Maximum patient weight	180kg	
<b>Model</b>		
Koval Shower Trolley L1-T1-HYD-ABS	99kg	299kg
Koval Shower Trolley L1-T1-EL-ABS	101kg	301kg

## Technical Specification – Hydraulic Shower Trolley

- Hydraulic stroke: 200mm
- Number of full control lever swings to reach a full stroke: 25 + 2
- Lift at normal temperature of 20°C: 4–7 seconds
- Reservoir ( $dm^3$ ): 0.2
- Maximum load force: 10kN
- Weight: 3.6kg

### CAUTION

Always use original replacement parts.  
Unauthorized intervention on hydraulics results in immediate loss of warranty.

## Technical Specification – Electric Shower Trolley

### Control box

- Output voltage: 24VDC
- Soft start and stop
- Audible battery alarm at approx. 25% capacity
- Protection class: IPX5
- Electronic overload protection (EOP)
- Emergency stop button



### Usage

- Duty cycle: max. 10% or 2 min of continuous use, followed by 18 minutes without operation
- Ambient temperature: +5°C to +40°C
- Storage temperature: -10°C to +50°C
- For one actuator
- Approvals: IEC60601-1, ANSI/AAMI ES60601, CAN/CSA-22.2 No 60601-1

### Mains cable

Length 3,2 m, 2 wires, cross section 1,0  $mm^2$ .

### NOTE:

Mains cable is replaceable by qualified personnel.

## Battery

- Li-Ion battery capacity: 24VDC, 1×2.9Ah that raises and lowers the system 40-times on a fully charged battery.
- The snap system allows the battery pack to be easily mounted on the charger and/or the control box using mounting brackets.
- Protection class: IPX5



## Usage

- Duty cycle: max. 10% or 2 min of continuous use, followed by 18 minutes without operation
- Ambient temperature: +5°C to +40°C
- Storage temperature: -15°C to +40°C
- Relative humidity: 20% to 80% - non-condensing
- Atmospheric pressure: 700 to 1060hPa
- Height above sea level: max. 3000 meters
- Flammability rating: UL94-V0
- Approvals: IEC60601-1, ANSI/AAMI ES60601, CAN/CSA-22.2 No 60601-1

## Charging accessory

- External charger CHJ2

## External charger

- Approx. charging time for BAJ1 battery pack: 5 hours
- Mains voltage: 100–240V / 50–60Hz
- Yellow LED-diode indicates that the battery is charging
- Green LED-diode indicates that the charger is connected to the mains
- Charging current up to 650mA
- Protection class: IPX5 (only when mounted vertically)
- 3.2m exchangeable mains cable (black straight)



## Usage:

- Ambient temperature: + 5°C to + 40°C
- Storage temperature: - 10°C to + 50°C
- Approvals: IEC60601-1, ANSI/AAMI ES60601 and CAN / CSA-22.2 No 60601-1

## Handset

- Handset for 1 actuator
- Protection class: IPX6 (washable)
- Number of buttons: 2
- Cable: coiled
- Button type: easy touch tactile switches
- Attach: via a hook



## Usage:

- Ambient temperature: + 5°C to + 40°C
- Storage temperature: - 10°C to + 50°C
- Approvals: IEC60601-1:2005 3rd edition, ANSI/AAMI ES60601-1:2005 3rd edition, and CAN/CSA-22.2 No 60601-1:2008.
- HB80 is designed and tested according to IPX6 (washable) pursuant to EN60601-2-52 cl. 201.11.6.6.101 (Machine washable medical beds)

## Actuator

- 24VDC permanent magnet motor
- Thrust of 6000N in “push” and 4000 N “in pull”
- Speed: 4.2mm/s
- Protection class: IPX6
- Noise level: 48dB(A); measuring method DS/EN ISO 3743-1, actuator not loaded.

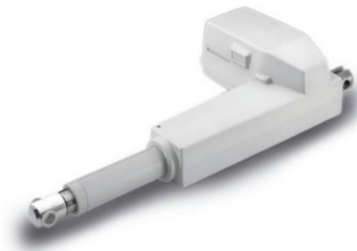

## Usage:

- Duty cycle: max. 10% or 2 min of continuous use, followed by 18 min. without operation
- Ambient temperature +5°C to +40°C
- Approvals: IEC 60601-1, ANSI/AAMI ES60601-1 and CAN/CSA-22.2 No 60601-1

**Electromagnetic compatibility – general:** The actuator systems bear the CE marking as an certificate of compliance with the EMC Directive 2014/30/EU. The systems are designed to meet all requirements of applicable standards and have been tested to meet the requirements of the IEC 60601-1-2 Standard.

## Emission

LINAK Actuator Systems are CISPR 11, Group 1, Class B products, and comply with IEC 61000-3-2, Class A and IEC 61000-3-3.

Test	Limit	Electromagnetic environment - guidance
<b>Radiated emission</b>	CISPR 11, Group 1, Class B	Device uses RF energy only for its internal function. Therefore, its RF emissions are very low and are not likely to cause any interference in nearby electronic equipment.

## Immunity test levels

Test	Compliance level	Electromagnetic environment - guidance
<b>Electrostatic Discharge (IEC 61000-4-2)</b>	Contact Discharge: ±8 kV Air Discharge: ±2 kV, ±4 kV, ±8 kV, ±15 kV	Floors should be wood, concrete or ceramic tile. If floors are covered with synthetic material, the relative humidity should be at least 30%.
<b>Radiated RF EM field (IEC 61000-4-3)</b>	80-2700 MHz; 1kHz AM 80 %; 10 V/m	<p>Portable and mobile RF communications equipment should be used no closer to any part of the device, including cables, than the recommended separation distance calculated from the equation applicable to the frequency of the transmitter.</p> <p><b>Recommended separation distance</b></p> <p><math>d = 1.2\sqrt{P}</math> for 80 MHz to 800 MHz  <math>d = 2.3\sqrt{P}</math> for 800 MHz to 2,7 GHz</p> <p>where <math>P</math> is the maximum output power rating of the transmitter in watts (W) according to the transmitter manufacturer and <math>d</math> is the recommended separation distance in meters (m).</p>

<b>Proximity fields form RF wireless communications equipment (IEC 61000-4-3)</b>	385 MHz; Pulse Modulation: 18 Hz; 27 V/m 450 MHz, FM $\pm$ 5 Hz deviation: 1 kHz sine; 28 V/m 710, 745, 780 MHz; Pulse Modulation: 217 Hz; 9 V/m 810, 870, 930 MHz; Pulse Modulation: 18 Hz; 28 V/m 1720, 1845, 1970 MHz; Pulse Modulation: 217 Hz; 28 V/m  2450 MHz; Pulse Modulation: 217 Hz; 28 V/m; 5240, 5500, 5785 MHz; Pulse Modulation: 217 Hz; 9 V/m	Portable and mobile RF communications equipment should be used no closer to any part of the device, including cables, than the recommended separation distance 30 cm.
<b>Rated power frequency magnetic fields (IEC 61000-4-8)</b>	30 A/m, 50 Hz	Power frequency magnetic fields should be at levels characteristic of a typical location in a typical commercial or hospital environment.
<b>Proximity magnetic fields (IEC 61000-4-39)</b>	30 kHz CW; 8 A/m  134.2kHz Pulse modulation 2.1 kHz; 65 A/m  13.56 MHz Pulse modulation 50 kHz; 7.5 A/m	The recommended separation distance between the medical device/system and magnetic emitters is at least 15 cm.

**WARNING** 

Use of accessories, transducers and cables other than those specified or provided by the manufacturer of this equipment could result in increased electromagnetic emissions or decreased electromagnetic immunity of this equipment and result in improper operation.

**WARNING** 

Mains plug is considered as disconnecting device from the mains. Make sure, that socket outlet is easily reachable and accessible to the operator.

## Wiring diagram

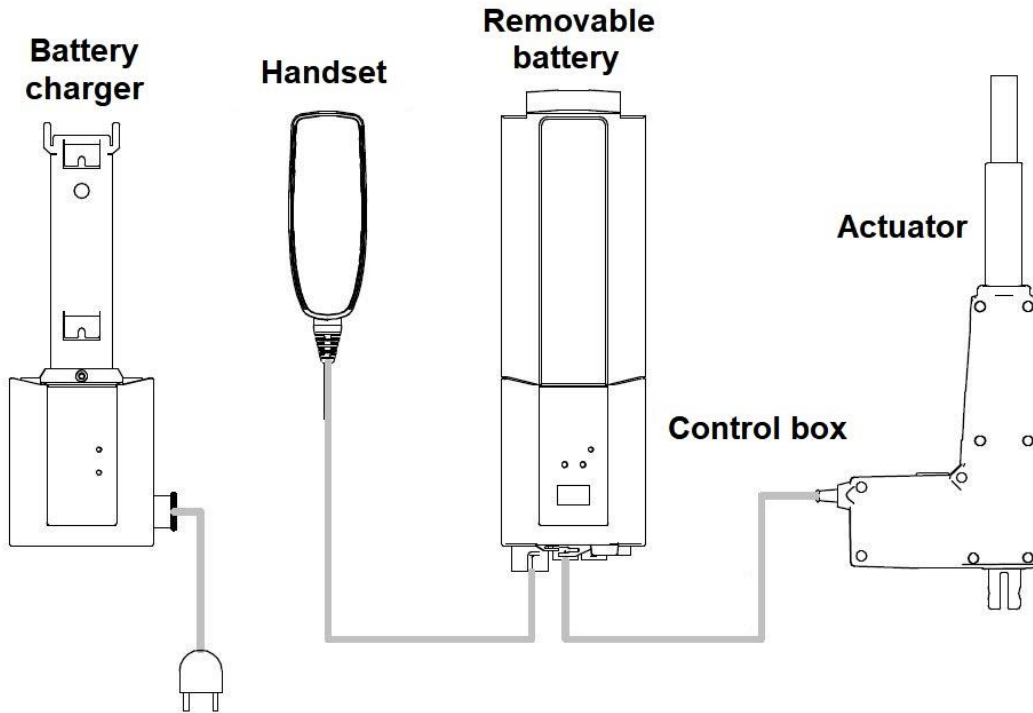

### Low Voltage Directive (LVD)

Actuator systems are in compliance with the Low Voltage Directive (LVD) (2014/35/EU). LVD ensures that electrical equipment within certain voltage limits provides a high level of protection for European citizens.

<b>Control box, Battery, External charger</b>	<b>IP X5</b>
IP	Ingress Protection
X	The protection against contact and ingress of objects is not specified for this product.
5	<b>Protect from water jets from any direction.</b> Water projected by a nozzle (6,3mm) against enclosure from any direction shall have no harmful effects.
<b>Handset, Actuator</b>	<b>IP X6</b>
IP	Ingress Protection
X	The protection against contact and ingress of objects is not specified for this product



6	<p><b>Protect from powerful water jets.</b></p> <p>Water projected from powerful jets (12.2mm) against the enclosure from any direction shall have no harmful effects.</p>
---	--

### BF-type protection

Entire Product Type BF Applied part: Protection against electric shock in accordance with EN/IEC 60601-1.



### End of Life Disposal

---

- All batteries in the product must be recycled separately. Batteries are to be disposed in accordance with national or local regulations.
- Mattress, head cushion, any other polymers or plastic materials etc. should be sorted as combustible waste.
- Lift systems having electrical and electronic components or an electrical cord should be disassembled and recycled per Waste of Electrical and Electronic Equipment (WEEE) or in accordance with local or national regulation.
- Components that are primarily made up of different kinds of metal (containing more than 90% metal by weight) should be recycled as metals.

# Dimensions

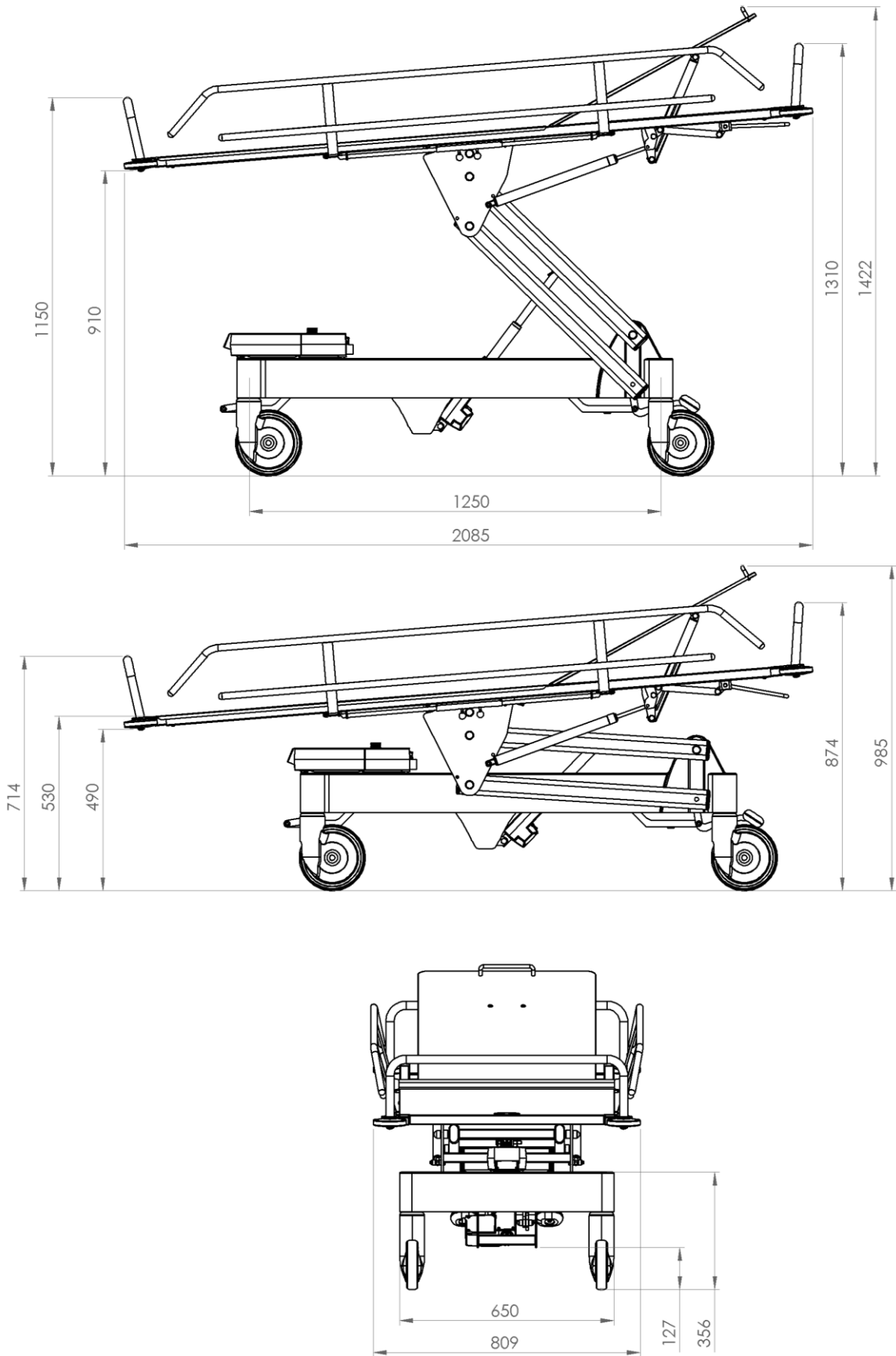



## Troubleshooting

### Troubleshooting for Koval Electric Shower Trolley

**NOTE:**

If the product does not work as intended, immediately contact Koval or your local Koval representative for support.

PROBLEM	ACTION
The electric shower trolley raises or lowers after the handset buttons are released.	<ol style="list-style-type: none"> <li>1 Activate the emergency stop button and remove the battery.</li> <li>2 Remove the patient from shower trolley and contact qualified personnel.</li> </ol>
The electric shower trolley does not raise or lowers when the handset buttons are pressed.	<ol style="list-style-type: none"> <li>1 Make sure the emergency stop button is not activated by turning the red button clockwise.</li> <li>2 Make sure that the battery is fully engaged in the battery compartment.</li> <li>3 Make sure that the battery is charged.</li> <li>4 Check connections and wiring.</li> <li>5 Do not exceed the maximum load.</li> <li>6 Wait for the system to cool down to the normal operating temperature. Observe the operating times and intervals (duty cycle).</li> </ol> <div style="border: 1px solid black; padding: 5px; margin-top: 10px;"> <p><b>WARNING</b> </p> <p><b>To avoid injuries, make sure that the patient is not left unattended at any time.</b></p> </div>
Difficulties when manoeuvring the shower trolley during transport.	<ol style="list-style-type: none"> <li>1 Verify that the central brake is released.</li> <li>2 Verify that all casters rotate and swivel freely.</li> <li>3 If the problem still persists, remove the patient from shower trolley and contact qualified personnel.</li> </ol>
The Koval Shower Trolley is emitting abnormal noise during lifting or transport.	Remove the patient from the shower trolley and contact qualified personnel.
Battery not charging.	<ol style="list-style-type: none"> <li>1 Verify mains connection and supply voltage.</li> <li>2 Replace the faulty battery charger.</li> </ol>

	3 Replace the drained battery.
<b>ALARM</b>	<b>ACTION</b>
The audible battery alarm beeps constantly.	<p>The battery must be charged – complete the transfer in progress and replace with a fully charged battery.</p> <div style="border: 1px solid black; padding: 5px;"> <p><b>WARNING</b> </p> <p><b>To avoid injuries, make sure that the patient is not left unattended at any time.</b></p> </div>
The audible battery alarm beeps after short operation time.	<p>Replace the battery and install a fully charged battery.</p> <p>If using a freshly charged battery and the audible battery alarm starts to beep after a short operation time, it is time to order a new battery.</p>
The tilting function of the shower trolley's top surface does not work.	Remove the patient from the Koval Shower Trolley and contact qualified personnel.

### Troubleshooting for Koval Hydraulic Shower Trolley

<b>PROBLEM</b>	<b>ACTION</b>
The Koval Shower Trolley does not raise when “pumping” the pedal.	Make sure that the Koval Shower Trolley is not in the highest position.
The Koval shower trolley does not descend when the pedal is pressed down.	Make sure that the Koval Shower Trolley is not in the lowest position.
The Koval Shower Trolley does not raise or lower when operating the pedal.	Remove the patient from the Koval Shower Trolley and contact qualified personnel.
Shower trolley top inclination does not work.	Remove the patient from the Koval shower trolley and contact qualified personnel.









**NOTE:** If the problem cannot be solved with the written troubleshooting actions, please contact qualified personnel.

**NOTE:** Before contacting our qualified personnel, be sure to prepare the serial number (SN) or the catalogue number (REF). You can find the SN on the product label located on the shower trolley top bracket (see Label placement). If the label text is damaged or the label is missing, be sure to have the delivery note or invoice number. This identification number helps reduce waiting times and improves service quality.



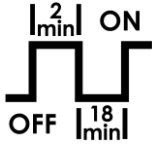

## Labels



### Label explanation



Manufacturer and Identification Data label	Catalogue number, Serial number, Batch code, Model name, Manufacturing date, Manufacturer, Safe working load.
Labels on electrical components	Manufacturer, product data.
Label on the gas spring	Serial number, Manufacturing date.
Warning labels about improper use:	
Warning label	Ensure rails are raised for transportation.
Warning label	Patient on this trolley must not be unattended.
Warning label	The maximum water allowance inside the shower trolley is 20 liters.

	Catalogue number
	Serial number
	Batch code
	Medical Device
	European Conformity Mark
	Type BF, Applied part: protection against electrical shock in accordance with EN/IEC 60601- 1.
	Separate electrical and electronic components for recycling in accordance with the European Directive 2012/19/EU
	Duty cycle: 10% or 2 min of continuous use, followed by 18 min not in operation
24VDC	Supply voltage
2.9Ah	Capacity
IPX5	Protection against splashing water
	Apply the brake
	Caution

### Symbol explanation

SWL 	Safe working load
	Product weight
	Read the Instruction for Use (IFU) before use
	Manufacturer

	Manufacturing date
	Distributor
	Indoor use



	Temperature range
	Humidity range
	Atmospheric pressure



## Label placement



## Product label:

**MODEL: SHOWER TROLLEY L1-T1-EL**

<b>REF</b> 10068932		(01) 03830075920135	 
<b>SN</b> 2021-00693/13		(10) 202100977	
<b>LOT</b> 2021-00977		(11) 211012	
<b>MD</b> EU 2017/745		(21) 20210069313	

IPX5  2021/10  3min ON  
OFF 1min



Made in Slovenia

**KOVAL**

Koval d.o.o.  
Loka pri Žusmu 9  
3223 Loka pri Žusmu

www.koval.si koval@koval.si

**MODEL: SHOWER TROLLEY L1-T1-HYD**

<b>REF</b> 10068930		(01) 03830075920098	 
<b>SN</b> 2022-00349/1		(10) 202200533	
<b>LOT</b> 2022-00533		(11) 220613	
<b>MD</b> EU 2017/745		(21) 2022003491	

2022/06 

Made in Slovenia

**KOVAL**

Koval d.o.o.  
Loka pri Žusmu 9  
3223 Loka pri Žusmu

www.koval.si koval@koval.si

## **Approvals and List of Standards**

---

Product complies with the European Regulation (EU) 2017/745 of the European Parliament and of the Council of 5 April 2017 on medical devices:

- Classified as Class I medical devices as set out in Annex VIII of Regulation (EU) 2017/745
- Complies with the provisions of Regulation (EU) 2017/745 “Medical Devices” and meets the essential requirements set out in Annex I of Regulation (EU) 2017/745
- The conformity for the purposes of the CE marking and conformity assessment according to the procedure from Annex IV of Regulation (EU) 2017/745
- The product also complies to the requirements of the following standards:
  - **ISO 17966: 2016,**
  - **EN ISO 15223-1:2016,**
  - **EN ISO 14971:2019,**
  - **EN 60601-1:2007,**
  - **EN 60601-1-2:2015,**
  - **EN 60601-1-6:2010.**

## Maintenance Record sheet

---

Date of Service	Completed Tasks	Technician	Signature	Next due

Design Policy and Copyright

© Koval 2022.

Pursuant to our policy of continuous improvements we reserve the right to modify our design without prior notice.

The content of this publication may not be reproduced in whole or in part without Koval's prior consent.

REV 02: 08/2022



KOVAL d.o.o.

Loka pri Žusmu 9  
3223 Loka pri Žusmu  
Slovenia

+ 386 3 747 19 14

✉ koval@koval.si

🌐 www.koval.si

Your care, our mission