

EN

INSTRUCTION FOR USE



MOBI PRO FLEXI /

MOVER – FLEXI – PRO: 11992146

Mover – Flexi – PRO is a mobile device designed to help a patient with a disability to be moved by a caregiver over short distances and to facilitate moving the patient from one sitting area to another. Mover – Flexi – PRO provides support to the patient when standing up from a bed, toilet, chair or a wheelchair. The product is intended for patients who are able to stand, but not necessarily walk.



WARNING 

To avoid injuries always read this Instruction for Use and accompanied documents before using the product.



Read Instruction for Use.

Contents

Foreword	1
Intended Use	2
Safety Instructions	3
Assembly of Mover – Flexi – PRO	4
Preparation	4
Before First Use (9 Steps)	4
Before Every Use (5 Steps)	4
Mover – Flexi – PRO driving directions.....	5
Parts designation	6
Product Description / Functions	6
Adjusting the flexible base width.....	8
Rotating the padded seats.....	9
Brakes	9
Adjusting the height of the knee support	10
Transfers with Mover – Flexi – PRO	10
From a Chair, Wheelchair, Bed or Toilet	10
To a Chair, Wheelchair, Bed or Toilet.....	11
Cleaning and Disinfection Instructions.....	12
Care and Regular Yearly Checkups	14
Mover – Flexi – PRO Storage and Transport.....	16
Mover – Flexi – PRO Operating Conditions.....	16
Technical Specifications	16
End of Life Disposal.....	17
Dimensions	18
Troubleshooting	19
Knee support is difficult to adjust.	19
Labels	20
Label placement	21
Approvals and List of Standards.....	22
Maintenance Record Sheet	23

Foreword

Thank you for choosing Koval equipment.

Your Mover belongs to a family of high-quality products intended to be used in the medical facilities, hospitals, nursing homes, rehabilitation units and other types of healthcare settings. Do not hesitate to contact us in case of queries about the operation or maintenance of your Koval equipment.

Please read this Instruction for Use thoroughly.

Thoroughly read and understand this Instruction for Use (IFU) before using your Mover. Information from this IFU is essential for proper operation and maintenance of the equipment. Follow these to keep your product safe and to ensure the functioning of your equipment to your satisfaction. Some of the information from this IFU is important for your safety; therefore, please read and understand to prevent any injuries. The product may only be used for its intended purpose.

WARNING

Unauthorized modifications of the Koval equipment may affect its safety. Koval will not be held responsible for any accidents, incidents or lack of performance as a result of any such unauthorized modifications.

Reporting Unexpected Operations or Events.

In case of unexpected operations or events contact Koval or your local Koval representative. The Koval contact information is printed on the last page of this IFU.

Serious Incident

In case of a serious incident in relation to this medical device involving the user or the patient; the user or the patient must report this serious incident to the medical device manufacturer or the distributor. The user must always report such serious incident to the local competent authority.

In the European Union, the user should also report the serious incident to the local competent authority in the member state where they are located.

Servicing and Support

Your Mover should be checked once a year by qualified personnel to ensure the operating safety of your product. See Care and Regular Yearly Checkups section. For further information please do not hesitate to contact Koval or your local Koval representative to

receive comprehensive support and servicing to maximize long-term safety, reliability and value of the product. For spare parts contact Koval or your local Koval representative. The Koval contact information is included on the last page of this IFU.

Definitions in this IFU:

WARNING

Safety warning. Failure to understand and follow this warning may result to personal injuries.

CAUTION

Failure to follow these instructions may cause damage to all or parts of the system.

NOTE

Describes important information about the correct use of this system or product.

When using this product always follow the appropriate WARNINGS.

Intended Use

This product is intended as an aid for people with disabilities (e.g., geriatric people, injured, people with disabilities) who are able to stand, but not necessarily walk, to stand up and to be safely moved by a caregiver over short distances. Mover facilitates patient movement from one location to another (e.g., from a chair, wheelchair to a toilet, bed). The device is intended for use in environment of care, such as senior/assisted living, special care facilities, medical facilities, hospitals, nursing homes, rehabilitation units and other healthcare settings. The device is intended specifically for indoor use.

This product should be used according to the intended purpose and these safety instructions. Everyone using this equipment should read and understand these instructions, which are included in this Instruction for Use (IFU). In case of doubts feel free to contact Koval or your Koval representative at any time.

Mover is intended to be used by appropriately trained caregivers familiar with the environment of care, as well as its common practices and procedures, and must follow the guidelines in the Instruction for Use (IFU). Mover should only be used for intended purpose specified in these Instruction for Use. Use for any other purpose is prohibited.

Product lifetime

The expected product lifetime is ten (10) years depending on the storage conditions and the frequency of use. The warranty period of the product is three (3) years.

Some product parts, such as casters, as well as seat and knee upholstery, which are subjected to wear, may need to be replaced during the device lifetime according to information in the Instruction for Use (IFU).

Transport damage

Upon delivery check the product and the packaging for damages. Observe the delivery date: visible damages should be reported within 2 days after delivery and hidden damages within 7 days after delivery.

Safety Instructions

WARNING ⚠

To prevent client falls or caregiver injuries make sure that there are two caregivers present during the transfer of a client if this is necessary according to the client state.

WARNING ⚠

To prevent the device from tipping or falling do not raise or lower other equipment, such as bed, shower trolley, lift, or bedside table, in its proximity.

WARNING ⚠

To avoid tipping and falling do not use the equipment on floor with recessed drains, holes or slopes exceeding a ratio of 1:50 (1.15°).

WARNING ⚠

To prevent entrapment, make sure to keep the client's arms on the crossbar and feet on a footplate.

WARNING ⚠

To prevent electric shock never use this device in close proximity to other electrical equipment.

WARNING ⚠

To prevent injuries the patient must never be left unattended.

WARNING ⚠

To prevent explosion or fire never use this product in an oxygen rich environment, near heat sources or flammable anesthetic gases.

Assembly of Mover – Flexi – PRO

Follow these steps:

- 1 Cut the straps securing the cardboard box to the pallet.
- 2 Unpack the Mover.
- 3 Remove all protective foil and foam from casters, seat upholstery and handles.
- 4 The Mover is now ready for use – no further installation is required.

Preparation

Before First Use (9 Steps)

- 1 Visually inspect the Mover for transport damages.

WARNING 

There is a 2-day deadline for reporting visible damages and a 7-day deadline for reporting hidden damages.

- 2 The packaging should be recycled according to local regulations.
- 3 Confirm that all parts of the product have been included in the package. Refer to Parts Designation section. In case of missing or damaged parts do NOT use the product!
- 4 Read the IFU.
- 5 Disinfection of the product should be carried out according to Cleaning and Disinfection Instructions.
- 6 Perform functionality testing of Mover. Refer to Care and Regular Yearly Checkups section.
- 7 Store the Mover in a dry, well-ventilated place out of direct sunlight.
- 8 IFU should be kept in a designated area and should be easily accessible at all times.
- 9 Have an emergency response plan readily available in case of a patient emergency.

Before Every Use (5 Steps)

1

WARNING 

To avoid injury, check for proper operation of basic functions before use.

- 2 Check that all parts are in place.
Refer to the Parts Designation section.
- 3 Carefully inspect the product for damages.

4 In case of missing or damaged parts do NOT use the product!

5

WARNING ⚠

To prevent cross-contamination always follow the disinfection instructions from this IFU.

Mover – Flexi – PRO driving directions

The driving direction during transport, as well as the left and right side are illustrated below (sides are marked pursuant to patient position).

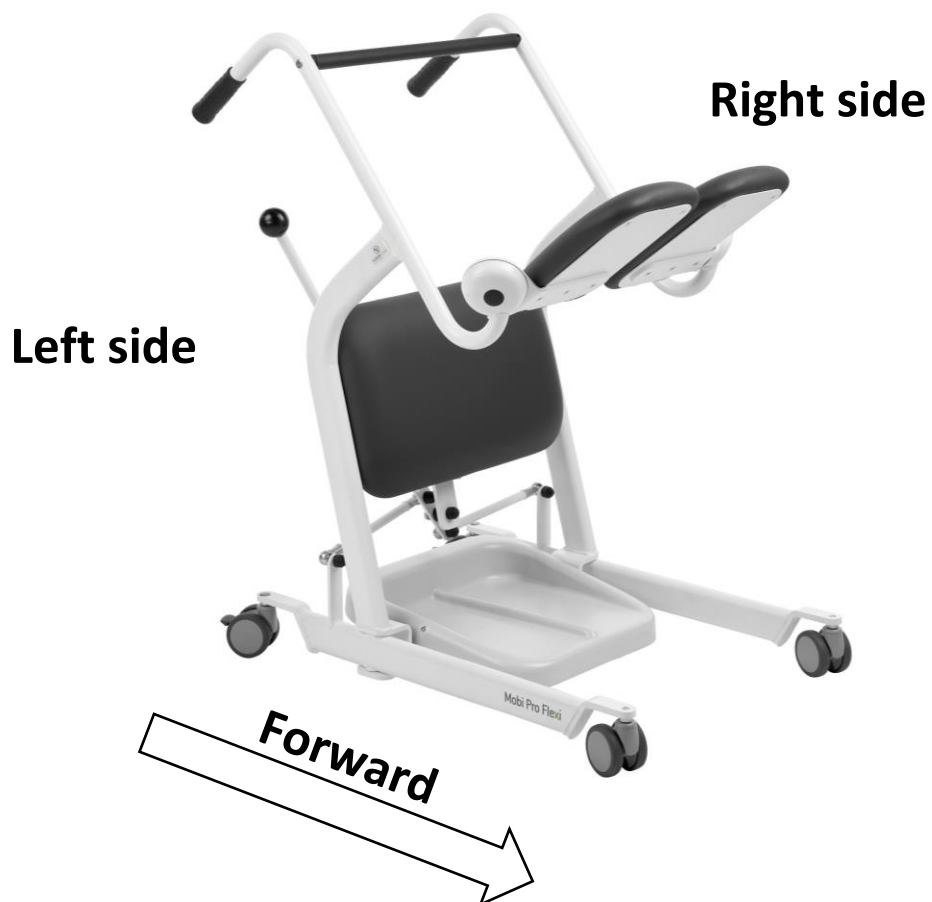

Parts designation



- | | |
|-------------------------|--------------------------------------|
| 1 Mover frame | 7 Double-wheel caster |
| 2 Flexible base | 8 Double-wheel caster with brake |
| 3 Plastic footrest | 9 Maneuvering handle |
| 4 Knee upholstery | 10 Lever for adjusting flexible base |
| 5 Right seat upholstery | 11 Crossbar |
| 6 Left seat upholstery | |

Product Description / Functions

Mover is a mobile (wheeled), non-self-propelled device designed to help a caregiver to safely move a patient with a disability (e.g., geriatric, injured, with disabilities) across short distances, and to facilitate transferring the patient from one sitting area to another (e.g., from a chair, wheelchair to a toilet, bed and back). It consists of a wheeled support structure with rotating padded seats, a crossbar, which the user can hold and pull by himself during repositioning, and two handles, which facilitate maneuvering the device by the caregiver.

The device is intended to be operated by the nurses or caregivers in environments of care, such as senior/assisted living, special care facilities, medical facilities, hospitals, nursing

homes, rehabilitation units and other health care settings. The equipment is intended for indoor use.

Rotating padded seats and a knee support with 50 mm of seamless padding provides maximum comfort and is easy to clean.

Plastic foot plate can be equipped with anti-slip tape to provide more grip.

Four swivel double-wheel casters with 75 mm of diameter for improved maneuverability. The rear casters are furnished with a brake. Mover ensures fast, stable and safe transfer of the patient.

The width of the mover's flexible base can be adjusted manually to allow easier access between or around the chair's feet or wheelchair's casters thus improving patient access.

The metal frame is electrostatically powder coated.

WARNING 

To avoid damage to the product, use the products exclusively to transfer patients. Transferring other objects is strictly prohibited.

WARNING 

To avoid damage to the equipment, this product should exclusively be used indoors.

WARNING 

To avoid injury, ensure weekly monitoring of all Mover functions.

Adjusting the flexible base width

The width of the flexible base of the Mover can be adjusted by means of a hand lever. It has three positions: narrow, middle and wide.

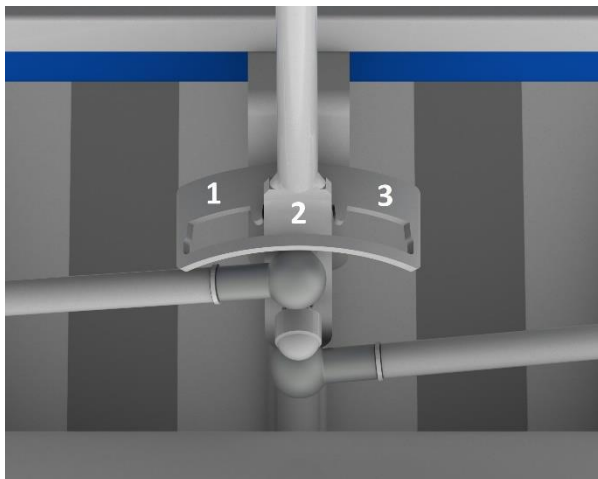

- | | |
|-----------------------------|--|
| 1 Left position (wide) - | Inner caster distance: 830 mm
Outer caster distance: 970 mm |
| 2 Middle position - | Inner caster distance: 640 mm
Outer caster distance: 770 mm |
| 3 Right position (narrow) - | Inner caster distance: 450 mm
Outer caster distance: 580 mm |



Rotating the padded seats



Rotate one part of the two-part seat in either direction from the open position to position underneath the patient.

WARNING ⚠

To avoid damages to the equipment always move the padded seats in the closed position.

WARNING ⚠

To prevent injuries the patient must never be left unattended.

Brakes

Rear casters with brakes:



Double wheel swivel casters Ø75 mm with a brake. Apply the break of each caster individually.

WARNING ⚠

To avoid injuries always lock the brake when Mover is stationary.

WARNING ⚠

To avoid injuries, ensure that the casters are locked when transferring the patient.

Adjusting the height of the knee support

The position of the knee support is height adjustable by 9 cm.

1. Unscrew the two PVC screws and adjust the height of the knee support.
2. Hold the knee support with one hand and tighten the PVC screws with the other hand.
3. Mover is ready for use.



Transfers with Mover – Flexi – PRO

From a Chair, Wheelchair, Bed or Toilet (9 steps)

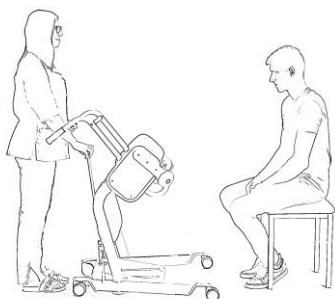

Fig. 1

- 1 Always inform the patient about what you are planning to do.
- 2 Open up both parts of the two-part seat by manually pulling them to the side and upwards.
- 3 Adjust the flexible base of the Mover, if needed, and approach the patient. (See Fig. 1.)

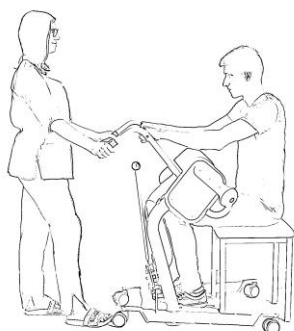

Fig. 2

- 4 Position the Mover to allow the patient to place the feet on the footrest with knees comfortably resting against the kneepad.
- 5 Apply both caster brakes. (See Fig. 2.)
- 6 Help or encourage the patient to grab the crossbar and use it to stand up.

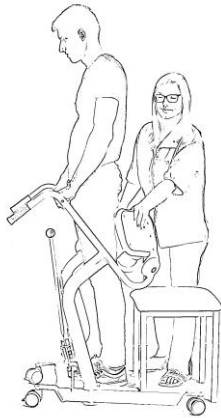

Fig. 3

7 Rotate both parts of the seat down. (See Fig. 3.)

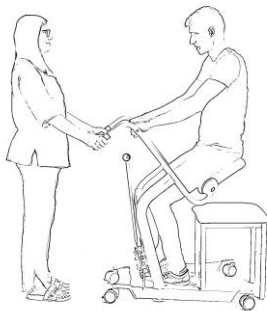

Fig. 4

8 Ask the patient to sit down. (See Fig. 4.)

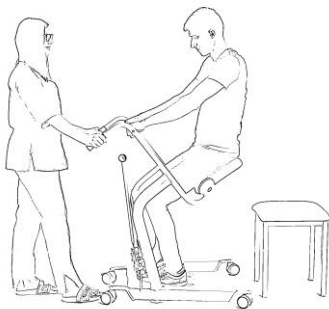

Fig. 5

9 Release the brakes and proceed with the transfer. (See Fig. 5.)

To a Chair, Wheelchair, Bed or Toilet

(8 steps)

- 1 Approach the chair and adjust the flexible base of the Mover, if needed.
- 2 Bring the patient over to the chair and apply the brakes.
- 3 Ask the patient to stand up.
- 4 Rotate the two parts of the seat up.

- 5 Ask the patient to sit down by holding the crossbar.
- 6 When seated, ask the patient to remove the feet from the footrest.
- 7 Release both caster brakes and move the Mover away.
- 8 Rotate the both parts of the seat down.

WARNING ⚠

When accommodating the patient all the brakes must always be applied to prevent patient falls.

WARNING ⚠

To avoid falls the patient must be positioned in accordance with this IFU.

WARNING ⚠

To avoid entrapment, ensure that the patient's arms are kept on the crossbar and feet on the footrest.

WARNING ⚠

To avoid the patient falls or caregiver injuries ensure that there are two caregivers present during the transfer of the patient, if this is necessary according to the patient state.

Cleaning and Disinfection Instructions

The Mover is recommended to be cleaned and/or disinfected regularly between each use, if necessary, or daily, as a minimum. If the Mover is soiled or in case of suspected contamination, follow the recommended cleaning and/or disinfection procedures below before using the equipment.

Clean the Mover with a damp cloth using warm water and a disinfectant cleaner.

To ensure proper cleaning and disinfection always follow the steps below:

Cleaning / Disinfection (Steps 1-8)

- 1 Wear protective gloves and goggles.
- 2 Mix the disinfectant according to the instructions on the product label or according to the mixing ratio in the IFU.
- 3 Apply the disinfectant on the Mover.
- 4 Allow for disinfection time according to the instructions on the product label.

- 5 Use a clean cloth to wipe all surfaces especially handles, the crossbar and knee upholstery.
- 6 Use a new cloth soaked in water to remove all traces of disinfectant. When removing disinfectant periodically rinse the cloth under running water.
- 7 If the traces of disinfectant cannot be removed, spray water with a temperature of approx. 25°C (77°F) on the affected parts and wipe with disposable towels. Repeat until all traces of disinfectant are removed.
- 8 Leave the parts to dry.

Repeated cleaning / disinfection should have no effect on the equipment during its expected service life of equipment.

Regularly clean with mild detergents to extend product lifetime.

WARNING ⚠

Do not use a steam washer, washing tunnel, or high pressure jet cleaners.

WARNING ⚠

To avoid eye or skin irritation never use disinfectants in the presence of a patient.

WARNING ⚠

To prevent cross-contamination always follow the disinfection instructions in this IFU.

WARNING ⚠

To avoid eye and skin damage always use goggles and gloves. In case of contact rinse with plenty of water. If eyes or skin becomes irritated, immediately contact a physician. Always read the IFU and the Material Safety Data Sheet (MSDS) of the disinfectant label.

WARNING ⚠

Do not clean the surface with abrasive sponges and cloths.

WARNING ⚠

The product should always be cleaned between patients.

Care and Regular Yearly Checkups

The Mover is subject to normal wear and tear; therefore, the following actions should be performed as specified to make sure that the product retains its original manufacturing specification.

Koval or your local Koval representative shall carry out a regular yearly checkup by prior agreement.

WARNING 

To avoid malfunction resulting in injury make sure to carry out regular inspections and follow the recommended maintenance schedule. In some cases, due to heavy use of the product and exposure to aggressive environment, more frequent inspections should be carried out. Local regulations and standards may be more stringent than the recommended maintenance schedule.

NOTE: Do not carry maintenance and servicing while the product is used.

Responsibilities of the Caregiver	AFTER EVERY USE	Every WEEK	Every YEAR
Disinfection	X		
Visually check all visible parts		X	
Visually check mechanical attachments		X	
Perform functionality testing		X	
Check and clean casters		X	
Check upholstery		X	
Regular yearly checkups by qualified personnel only			X

WARNING 

To avoid injuries of the patient and caregiver never modify the equipment or use incompatible parts.

Responsibilities of the Caregiver

Responsibilities of the caregiver shall be carried out by personnel with sufficient Mover knowledge following the instructions in this IFU.

Daily

Disinfection

- Disinfect the Mover immediately after every use. Use recommended concentrations of standard disinfectants and cleaning agents. For additional cleaning/disinfecting instructions see Cleaning and Disinfection Instructions section.

Weekly

Visually check all exposed parts

- Particularly check areas exposed to physical contact with the patient or the caregiver. Check for potential cracks or sharp edges that could lead to injuries by the patient or the caregiver or that could become unhygienic.

Test functionality by:

- Verifying smooth operation of the adjustable flexible base.
- Verifying smooth rotating operation of the rotating padded seats.
- Checking the brakes.

Checking and cleaning casters

- Check that all casters are securely fixed and can rotate and swivel freely. Always clean with water (the functioning can be affected by soap, hair, dust and chemicals from the floor cleaning solutions).

Checking the upholstery

- Verify that there are no cracks or tears. In the event of damage replace damaged parts to avoid cross contamination. (See Parts Designation section)

Yearly Checkups by Qualified Personnel Only

Mover must be checked once a year in accordance with the Maintenance and Repair Manual.

WARNING

To avoid injuries and/or diminished safety of the product the maintenance activities must be carried out at set intervals by qualified personnel with appropriate tools and parts, as well as proper knowledge of the procedures. Qualified personnel must be certified for the maintenance of this device.

NOTE: All Caregiver Obligations are to be checked when performing the Qualified Personnel Service.

Mover – Flexi – PRO Storage and Transport

The Mover must be stored in a dry, well-ventilated area at room temperature and out of direct sunlight (UV-radiation). The storage temperature must range from -40°C to 70°C, storage humidity must range from 20% to 80%. Atmospheric pressure: 500 to 1060hPa. Avoid excessive pressure on the upholstery during storage. Follow all the necessary precautions during transport: to avoid damage of the equipment always close the padded seats.

CAUTION:

Failure to lock the casters in the braking position can cause the Mover to move automatically.

Mover – Flexi – PRO Operating Conditions

The operating temperature must range from +5°C to +40°C. Humidity must range from 20% to 80% and atmospheric pressure must range from 700 to 1060hPa.

Technical Specifications

11992146 - MOVER – FLEXI – PRO/Mobi Pro Flexi



Rotating padded seats
Seamless padding (50 mm)
Manually adjustable flexible base with three positions:
 Inner caster distance: 450 mm, 640 mm, 830 mm
 Outer caster distance: 580 mm, 770 mm, 970 mm
Crossbar
Knee support
Front swivel double wheel casters Ø75 mm
Rear swivel double wheel casters Ø75 mm with brake
Maneuvering handles
Footrest height: 70 mm
Höjd: 1050 mm
Length: 930 mm
Width: 640 mm
Weight: 33 kg
Safe working load: 180 kg

NOTE:
Measurements can deviate for +/- 2%.

End of Life Disposal

- Upholstery and any other polymers or plastic materials etc. should be sorted as combustible waste.
- Components that are primarily made up of different kinds of metal (containing more than 90% metal by weight), should be recycled as metals.

Dimensions

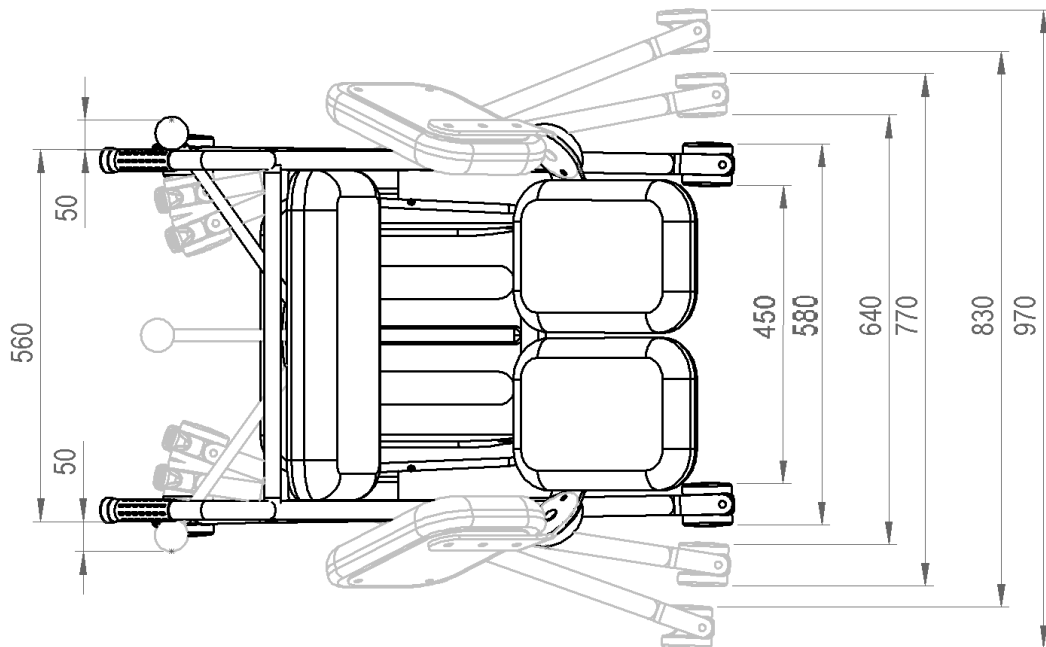
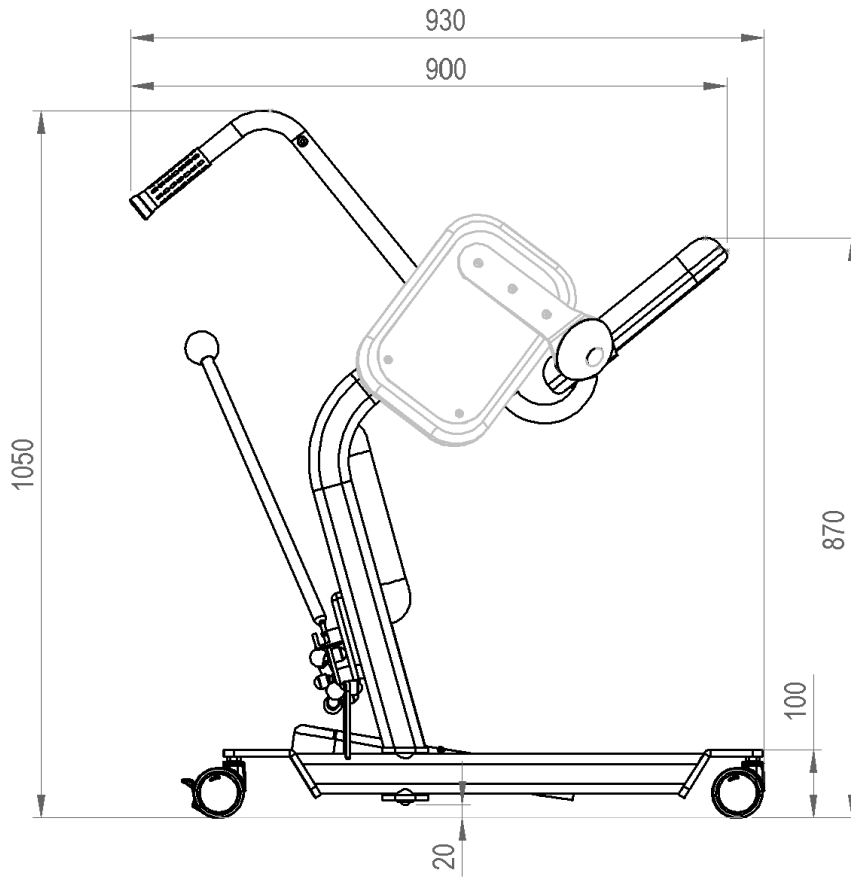

Troubleshooting

Troubleshooting for Mover – Flexi – PRO

NOTE: If the product does not work as intended, immediately contact Koval or your local Koval representative for support.

PROBLEM	ACTION
Manually adjustable flexible base cannot be opened or closed.	1 Check flexible base mechanism for damage. 2 Immediately stop using the Mover and contact qualified personnel.
Manually adjustable flexible base cannot be opened or closed / noise present during opening.	1 Check flexible base mechanism for damage. 2 Immediately stop using the Mover and contact qualified personnel.
Difficulties when maneuvering the Mover during transport.	1 Verify that all brakes are released. 2 Verify that all casters rotate and swivel freely. 3 If the problem still persists, immediately stop using the Mover and contact qualified personnel.
Rotating padded seats are difficult to open or close.	Check for debris or hair in the seat pivot. Clean, if needed.
Knee support is difficult to adjust.	1 Check knee support for damage. 2 Check for debris. Clean, if needed.













NOTE: If the problem cannot be solved by following the troubleshooting above, please contact qualified personnel.

NOTE: Before contacting our qualified personnel, be sure to prepare the serial number (SN) or, alternatively, have the product next to you. You can find the SN on the product label located on the inner side of the left mover leg (Refer to Label placement section) or on the left side of the plastic footrest. The delivery note or the invoice number can also be used to identify your product. This identification number helps reduce waiting times and improves service quality.







Labels

Label explanation

Manufacturer and Identification Data Label	Catalogue number, Serial number, Batch code, Model name, Manufacturing date, Manufacturer, Safe working load.
Warning Label	Warnings about improper use

	Catalogue number
	Serial number
	Batch code
	European Conformity Mark
	Warning: pinching of hands
	Apply the brake
	MD Medical Device
	Indoor use
	Distributor
	Temperature range
	Humidity range
	Atmospheric pressure range

Symbol explanation

SWL 	Safe working load
	Product weight
	Read the Instruction for Use (IFU) before use
	Caution
	Manufacturer
	Manufacturing date

Label placement



Product label:

MODEL: MOVER - FLEXI - PRO			(01) 03830075923396 (10) 202400450 (11) 240417 (21) 2024002571	 
REF	11992146			
SN	2024-00257/1			
LOT	2024-00450			
MD	EU 2017/745			
 Koval d.o.o. Loka pri Žusmu 9 3223 Loka pri Žusmu		2024/04  33 kg  180 kg	   Made in Slovenia	 www.koval.si koval@koval.si

Approvals and List of Standards

Product complies with the European Regulation (EU) 2017/745 of the European Parliament and of the Council of 5 April 2017 on medical devices:

- Classified as Class I medical devices as set out in Annex VIII of Regulation (EU) 2017/745
- Complies with the provisions of Regulation (EU) 2017/745 “Medical Devices” and meets the essential requirements set out in Annex I of Regulation (EU) 2017/745
- The conformity for the purposes of the CE marking and conformity assessment according to the procedure from Annex IV of Regulation (EU) 2017/745
- The product also complies to the requirements of the following standards:
 - **EN ISO 21856:2022,**
 - **EN ISO 15223-1:2017-02 (eq. EN ISO 15223-1:2016),**
 - **EN ISO 14971:2019.**

Maintenance Record Sheet

Date of Service	Completed Tasks	Technician	Signature	Next due

Design Policy and Copyright

© Koval 2024.

Pursuant to our policy of continuous improvements we reserve the right to modify our design without prior notice.

The content of this publication may not be reproduced in whole or in part without Koval's prior consent.

REV 02: 01/2024



KOVAL d.o.o.

Loka pri Žusmu 9

3223 Loka pri Žusmu

Slovenia

Your care, our mission

☎ + 386 3 747 19 14

✉ koval@koval.si

🌐 www.koval.si